



ALUMINIUM EXTRUSIONS

HEAT PUMP INDUSTRY

PROFILE
CATALOGUE

WWW.RFM.CO.ZA



Grow Your
Business
with Us!

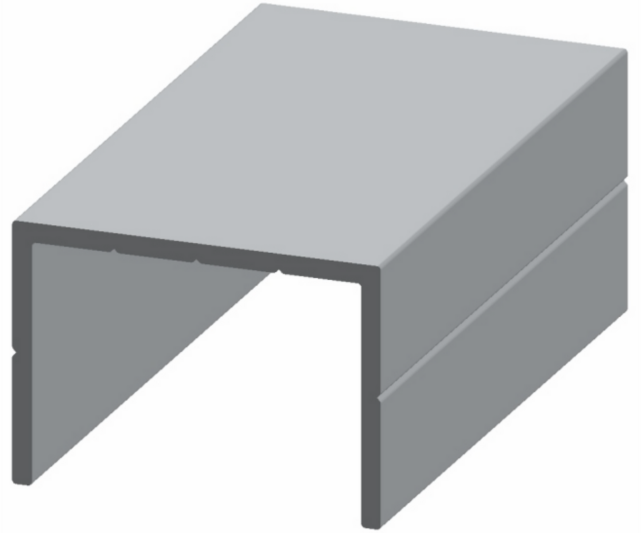

» About Us

RF Metals is an Aluminium profile stockist that was established in Cape Town, with over 20 years of experience in the industry. It had grown well with it's ethos of a customer orientated culture and opened another branch in Johannesburg in 2021 to bring its quality products and service offering to Gauteng. RF Metals stock, amongst others both Wispeco and Hulamin's local quality aluminium extrusions and all branches are proud CDP's (Crealco Distribution Partners). All CDP's are linked to the Crealco CDP supply website page.

WE RETAIL NATIONALLY

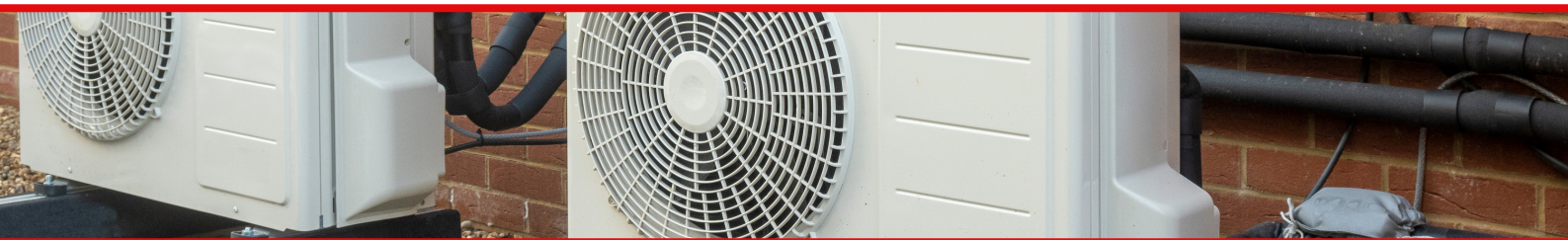

Contact Us

+27 21 5510125 CPT

+27 87 164 1888 JHB

www.rfm.co.za

[@rfmetals](https://www.facebook.com/rfmetals)

So what are you waiting for,
entrust your business to us.

3 D

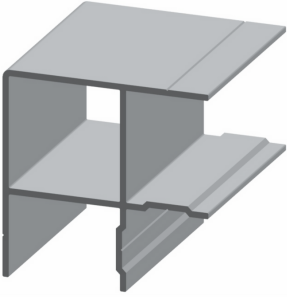

CODE
VHP-54000 DESCRIPTION
DIE 54000
25MM POST

3 D

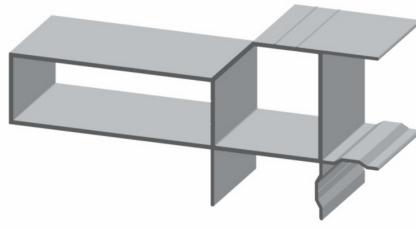

CODE
VHP-55346 DESCRIPTION
DIE 55346
45MM BASE
SECTION

3 D

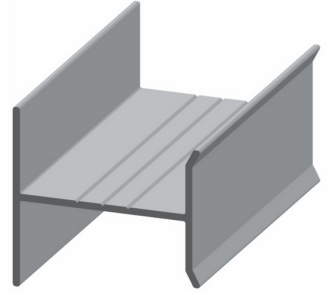

CODE
VHP-70846 DESCRIPTION
DIE 70846
H SECTION HEAT
PUMP

2 D

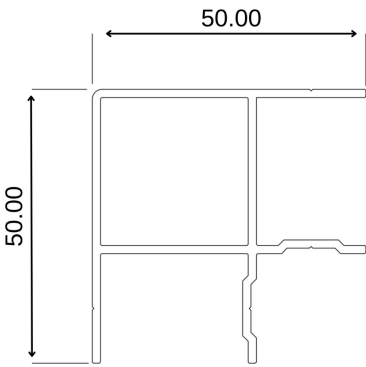

2 D

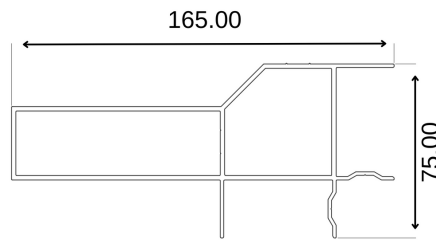

2 D

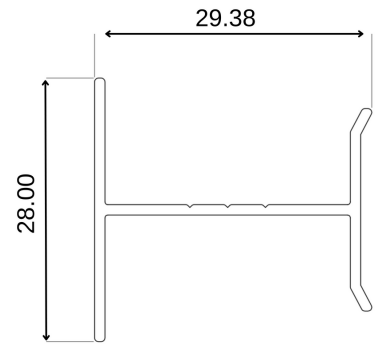

3 D

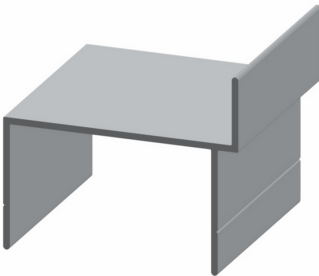

CODE
VHP-28338 DESCRIPTION
DIE 28338
45MM DOOR JAMBS

3 D

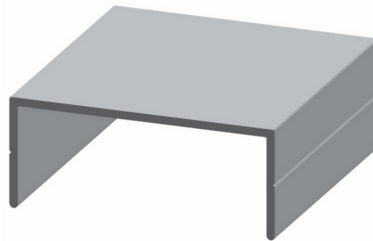

CODE
VHP-28357 DESCRIPTION
DIE 28357
D/CHANNEL

3 D

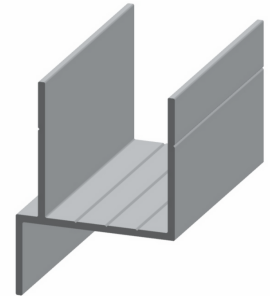

CODE
VHP-32409 DESCRIPTION
DIE 32409
25MM DOOR FRAME

2 D

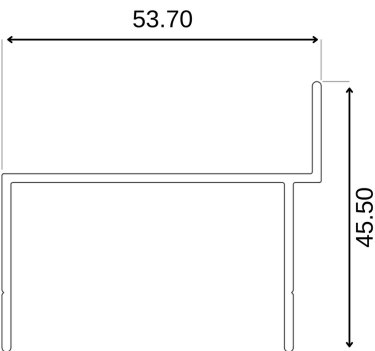

2 D

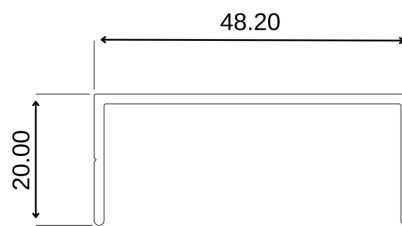

2 D

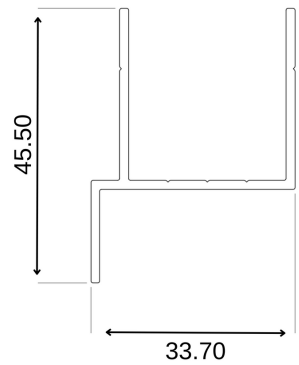

3 D

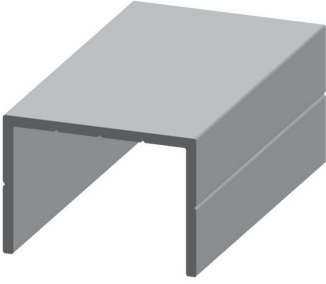

CODE
VHP-31410

DESCRIPTION
**DIE 31410
25MM DOOR
CHANNEL**

2 D

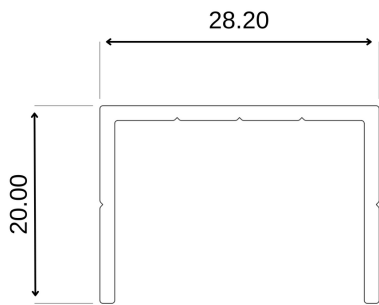

**RFM**
ALUMINIUM EXTRUSIONS